

Operating instructions

for built-in refrigerators

GB

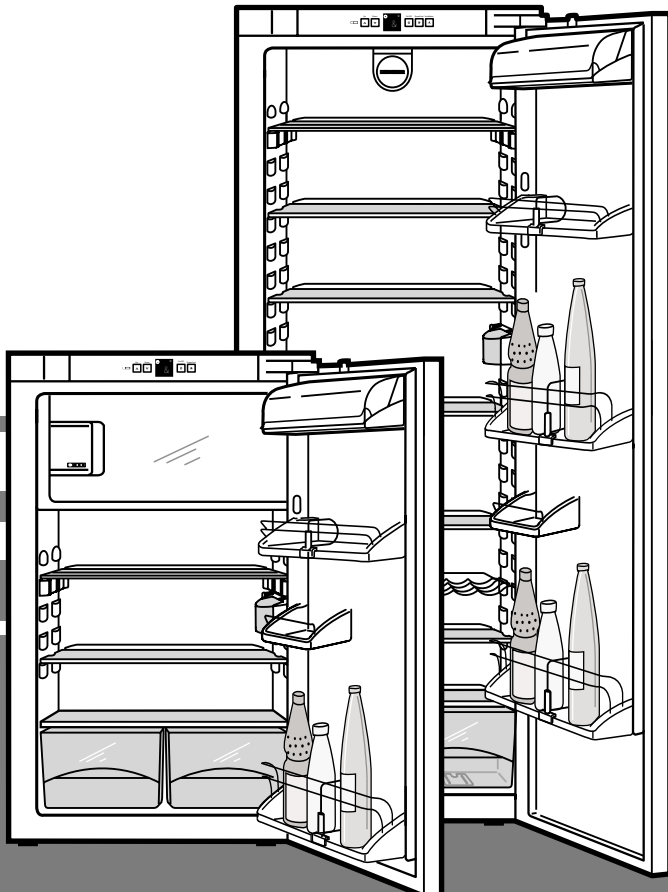

7082 446 - 00

IKP/IK....6 0206

The appliance at a glance

Operating and control elements, fig. A1

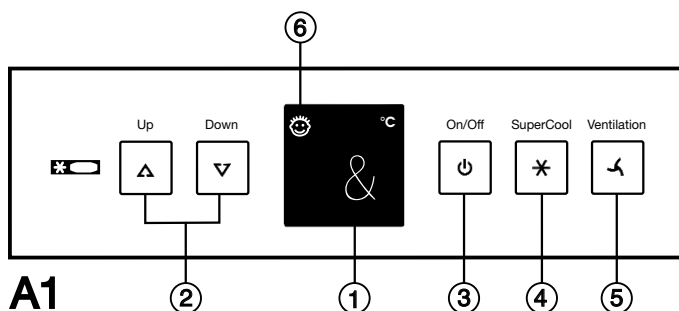

- ① Temperature display and setting display
- ② Temperature setting buttons:
UP = higher, DOWN = lower,
recommended setting: 5°C
- ③ On/off button
- ④ SuperCooling button, lit = function activated
For fast cooling of food. Switches off automatically after approx. 6 hours.
- ⑤ Fan button* for re-circulated air cooling,
lit = function activated,
for an even temperature distribution throughout the refrigerator
- ⑥ Child-proof lock display, lit = function activated, prevents the appliance from being switched off accidentally. See 'Additional functions' for more information.

Type/Data plate, fig. A2

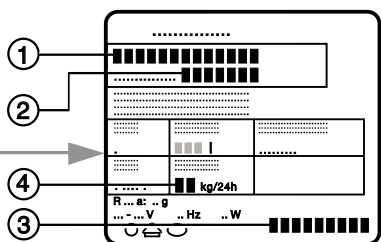

- ① Type designation
- ② Service number
- ③ Appliance number
- ④ Freezing capacity in kg/24 hours*

Description of appliance and equipment

Refrigerator compartment, approx. 5°C

- Operating and control elements
- Butter and cheese compartment
- Fan* for re-circulated air cooling
- Sectioned shelves* for tall containers
- Adjustable bottle/can holder*
- Adjustable-height* jar racks/egg tray*
- Adjustable* storage shelves
- LED interior light

Freezer compartment*, approx. -18°C

- Ice-cube tray*
- Defrost water drain
- Bottle shelf*
- Coldest area of the refrigerator compartment, suitable for cold-sensitive and highly perishable foods
- Type/Data plate
- Vegetable bins on roller plates*
- Vegetable, salad and fruit bins
- Adjustable feet at front

A

Congratulations on your purchase. In choosing this appliance you have opted for all the benefits of state-of-the-art refrigeration technology, guaranteeing you top quality, a long life span and excellent reliability. The features on your appliance have been designed to ensure maximum convenience - day in, day out. This appliance has been manufactured with recyclable materials using an environmentally friendly process, so together you and we are making an active contribution to the preservation of our environment. To get to know all the benefits of your new appliance, please read the information contained in these operating instructions carefully. We wish you much pleasure with your new appliance.

Keep these operating instructions in a safe place and pass them on to the next owner, where applicable. The operating instructions apply to several models. Differences may therefore occur.

Contents	Page
Operating instructions	
The appliance at a glance	10
Contents	11
Safety regulations	11
Notes on energy saving	11
Safety instructions and warnings	12
Disposal notes	12
Installation and ventilation information	12
Connecting to the mains.....	12
Operation and control elements.....	13
Switching the appliance on and off	13
Setting the temperature	13
Temperature display.....	13
SuperCooling	13
Fan switch.....	13
Additional functions	13
Child-proof lock	13
Display brightness*	13
Storage, shelf arrangement.....	14
Arranging food in the refrigerator	14
Changing shelf arrangement.....	14
Freezer compartment*	15
Freezing	15
Notes on storage	15
Making ice cubes	15
Defrosting, cleaning	16
Troubleshooting.....	17
Customer service and type plate.....	17

Safety regulations §

- The appliance is intended for chilling food and, if equipped with a freezer compartment*, for freezing and storing frozen food and for making ice. It is designed as a household appliance. If used commercially, the relevant regulations on commercial use must be observed.
- The appliance is set to operate within specific ambient temperature limits according to its climate rating. These temperature limits should not be exceeded. The correct climate rating for your appliance is indicated on the type plate. This is explained as follows:

Climate rating	Set for ambient temperatures of
SN	+10°C to +32°C
N	+16°C to +32°C
ST	+18°C to +38°C
T	+18°C to +43°C

- The refrigerant circuit has been tested for leaks.
- The appliance complies with the relevant safety regulations and EC directives 73/23/EEC and 89/336/EEC.

Notes on energy saving !

- Ensure that there is adequate space around the appliance for ventilation and air extraction.
- Avoid keeping the door open for too long.
- Store food logically. Do not exceed the storage period specified.
- Keep all food properly packed and covered so as to avoid its frosting up on the outside.
- Always allow hot food to cool to room temperature before placing in the appliance.
- Defrost frozen food in the refrigerator.
- If an ice layer forms in the freezer compartment*, you should defrost it. This will improve the cold transfer and reduce energy consumption.

Safety instructions and warnings

Disposal notes

The packaging is designed to protect the appliance and individual components during transport and is made of recyclable materials.



- Corrugated board/board
- Moulded polystyrene (foamed, CFC-free polystyrene)
- Polythene bags and sheets
- Polypropylene straps

- **Keep packaging materials away from children - polythene sheets and bags can cause suffocation!**

- Please return the packaging material to your nearest official collection point so that the various materials can be reused or recycled as far as possible.

Your old appliance:

This contains some reusable materials and should be disposed of properly - not simply with unsorted household refuse.



- Disable discarded appliances immediately by removing the plug and cutting through the connection cable. **Remove the spring-action or bolt catch from the appliance so that playing children cannot become trapped inside and suffocate.**
- Ensure that the refrigerant circuit of appliances that are no longer needed is not damaged.
 - Details of the refrigerant can be found on the type plate.
 - Appliances which are no longer needed must be disposed of in a professional and appropriate way, in accordance with the current local regulations and laws.

Technical safety

- To prevent injury or damage to the unit, the appliance should only be transported wrapped and set up by two people. 
- The refrigerant R 600a is environmentally friendly but flammable.
- Do not damage the refrigerant circuit pipes. Splashes of refrigerant can harm your eyes or ignite.
- If refrigerant escapes, remove all naked flames or sources of ignition in the vicinity of the leak, disconnect the appliance from the mains and ventilate the area well.
- In the event that the appliance is damaged, contact the supplier immediately before connecting to the mains.
- To guarantee safe operation, ensure that the appliance is set up and connected as described in these operating instructions.
- Disconnect the appliance from the mains if any fault occurs. Pull out the plug (not by pulling on the mains cable) or switch off or remove the fuse.
- **Any repairs and work on the appliance should only be carried out by the customer service department, as unauthorised work could prove highly dangerous for the user.** The same applies to changing the mains power cable.

Safety during use

- Do not store explosives or sprays using combustible propellants such as butane, propane, pentane, etc. in the appliance. Electrical components might cause leaking gas to ignite. You can identify such sprays by the printed contents or a flame symbol. 
- Only store high-percentage alcohol in tightly sealed, upright containers.
- Do not allow naked flames or ignition sources to enter the appliance.
- Do not use electrical appliances inside the appliance (e.g. steam cleaners, heaters, ice makers, etc.).
- Do not stand on the plinth, drawers or doors or use them to support anything else.
- This appliance is not intended for use by persons (including children) with reduced physical, sensory or mental capabilities or lack of experience and knowledge unless they have been given initial supervision or instruction concerning use of the appliance by a person responsible for their safety. Children should be supervised to ensure that they do not play with the appliance.

- Avoid prolonged skin contact with cold surfaces or chilled/frozen food. This could cause pain, numbness and frostbite. In the case of prolonged skin contact, protective measures should be taken, e.g. gloves should be worn.
- Do not eat ice cream, particularly ice lollies or ice cubes, immediately after taking them from the freezer compartment as there is a risk of "burning" because of the very cold temperatures.
- Do not consume food which has been stored for too long, as it could cause food poisoning.

Installation and ventilation information

- Avoid positioning in direct sunlight or next to an oven, radiator or similar.
- **Do not block the ventilation areas. Always ensure that the appliance is properly ventilated.**
- Standard EN 378 specifies that the room in which you install your appliance must have a volume of 1 m³ per 8 g of R 600a refrigerant used in the appliance, so as to avoid the formation of inflammable gas/air mixtures in the room where the appliance is located in the event of a leak in the refrigerant circuit. The quantity of refrigerant used in your appliance is indicated on the type plate on the inside of the appliance.
- Only install the refrigerator/freezer in stable furniture.
- Please follow the enclosed installation instructions.

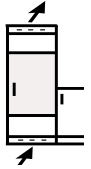

Connecting to the mains

Power supply (AC) and voltage

at the operating point must comply with the details on the type plate. The type plate is located on the inside left of the appliance, fig. A.

- **The appliance must be connected with a properly installed fused socket.**
- The socket must have a 10 A fuse or higher. It must be away from the back of the appliance and easily accessible.
- *Do not*
 - connect to stand-alone inverters and
 - operate with so-called energy-saving plugs - this can damage the electronic system,
 - connect to the supply with other electrical equipment using a distributor strip or an extension cable - risk of overheating or fire.
- When removing the mains cable from the back of the appliance, remove the **cable holder** to prevent vibration noise.

The wires in the mains lead are coloured in accordance with the following code: green/yellow = earth, blue = neutral, brown = live.

Warning! This appliance must be earthed.

Non-rewireable plugs BS 1363

If this machine or appliance is fitted with a non-rewireable plug, the following information applies: If the socket outlets are not suitable for the plug supplied with this product, it must be cut off and an appropriate plug fitted. The plug cut from the flexible cord should be disposed of and on no account be inserted into a 13 A socket elsewhere in the house (electric shock hazard).

The fuse cover must be re-fitted when changing the fuse, and if the fuse cover is lost the plug must not be used until a suitable replacement is obtained. The colour of the correct replacement cover is that of the coloured insert in the base of the plug, or the colour that is embossed in words on the base of the plug (as applicable to the design of the plug fitted). The correct rating of the replacement fuses that are ASTA approved to BS 1362 should be fitted. Replacement fuse covers may be purchased from your local electrical suppliers, electricity showroom or approved service agent.

Operation and control elements

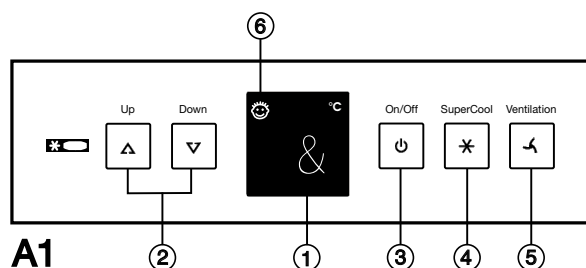

A1

You are advised to clean the appliance before switching it on for the first time (see "Cleaning").
If your appliance has a freezer compartment, switch it on approx. 2 hours before filling the freezer with frozen food for the first time.

Switching the appliance on and off

- **To switch on:** Press the on/off button ③ so that the temperature display lights up or flashes.
 - The lighting will light up when the door is open.
- **To switch off:** Press the on/off button for approx. two seconds so that the temperature display goes out.

Setting the temperature

The appliance is pre-set for normal operation. We recommend temperatures of +5°C in the refrigerator. This will ensure an average frozen food temperature of approx. -18°C in the freezer compartment*.

- **To reduce the temperature:**
Press the DOWN button ②.
- **To increase the temperature:**
Press the UP button ②.
 - While you are entering the temperature, the **set temperature will flash** on the display.
 - When you press the temperature setting buttons for the first time, the **most recent setting** (known as the "**reference setting**") is displayed.
 - You can change the settings in increments of 1°C by briefly pressing the buttons again. If the buttons are held down the temperature setting will change faster.
 - The system switches over automatically about 5 seconds after the button was last pressed and displays the **average** cooling temperature (known as the "**actual setting**").
 - You can change the temperatures in the refrigerator between 9°C and 2°C.

Temperature display

The average temperature in the refrigerator compartment is displayed in normal mode.
If "F0" to "F5" appears in the display, the appliance has a fault. Consult the customer service department indicating the fault number displayed, so that they can arrange for your appliance to be serviced accurately and quickly.

SuperCooling

The SuperCooling button switches the appliance to maximum cooling.

It is recommended particularly if you wish to cool *large* quantities of food, drinks, freshly baked cakes or meals rapidly.

- **To switch on:** Press the SuperCooling button ④ briefly so that it lights up. The refrigerator temperature will drop to its lowest value.

Note: The SuperCooling function uses slightly more energy. After approx. 6 hours, however, the appliance switches back *automatically* to normal energy-saving operation.

Fan switch*

You can use the fan switch ⑤ for re-circulated cooling as required to:

- chill large quantities of fresh food faster;
- keep the temperature evenly distributed throughout the entire refrigerator compartment. The intensive air circulation eliminates the different temperature areas present in normal operation. All food will be refrigerated to more or less the same extent.
- You are recommended to always use the fan switch:
 - in *high* room temperatures (approx. 30°C or higher) or
 - if the air humidity is high, e.g. during the summer.
- **To switch on/off:** Press the fan button ⑤ briefly so that it lights up (**dark = off**).

Note: The energy consumption will increase when the fan is switched on.

- To save energy, the fan will switch off automatically when the door is open.

Additional functions

In set-up mode you can set the **child-proof lock** and adjust the **brightness of the display***

Activating set-up mode:

- Press the SuperCooling button for approx. 5 secs - the SuperCooling button flashes - the display shows **c** for child-proof lock.

Note: the value to be altered flashes.

- Select the required function by pressing the Up/Down button:

c = child-proof lock or
h = brightness.

- Now select/acknowledge the function by pressing the SuperCooling button briefly:

- For **c** = **child-proof lock**, press the Up/Down button to select **c1** = child-proof lock **on** or **c0** = child-proof lock **off** and acknowledge with the SuperCooling button. When the symbol ⑥ is lit, the child-proof lock is activated.
- For **h** = **brightness**, press the Up/Down button to select **h1** = **minimum** to **h5** = **maximum** brightness and acknowledge with the SuperCooling button.



Exiting set-up mode:

- To exit the set-up mode, press the On/Off button; after 2 mins. the electronic system switches over automatically.
 - The normal operating mode is activated again.

Storage, shelf arrangement

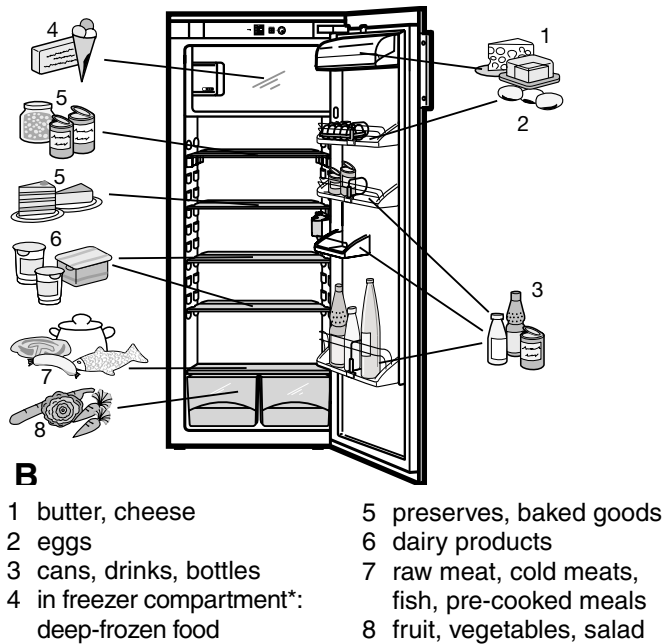

Arranging food in the refrigerator

Because of the natural circulation of air in the refrigerator compartment, the temperature in different parts of the refrigerator will differ, each area being suitable for different types of food. The refrigerator is coldest just above the vegetable bins and against the rear wall (suitable for sausage and meat products etc.); it is warmest at the front at the top and in the door (suitable for spreadable butter, cheese etc.). See fig. **B** for food storage suggestions.

Notes on cooling

- Store food so that the air can circulate freely and ensure that the food is not packed too closely together. *Do not* cover the fan slits* at the back, otherwise the refrigerating capacity will be impaired!
- Food which gives off or absorbs odours and flavours, and liquids should always be stored covered or in closed containers.
- Always store food which gives off or is sensitive to ethylene gases such as fruit, vegetables and salads separately or wrapped in order not to affect their storage life; e.g. do not store apples together with kiwis or cabbage.

Changing shelf arrangement

- You can change the position of the **jar rack*** and remove all door racks for cleaning, fig. **C**: Slide the door rack up, pull out towards you and replace in reverse order.
- By adjusting the **bottle/can holder** you can protect the bottles from falling over when the door is opened and closed. If your appliance has the equipment illustrated in fig. **C1**, always hold by the plastic handle.
 - The holder can be removed for cleaning:
 - If your appliance has the equipment illustrated in fig. **C1**: pull the bottom edge of the holder towards you and lever out.
 - If your appliance has the equipment illustrated in fig. **C2**: slide the front edge of the holder up and lever out.
- **Shelves*** (grids or glass shelves) can be adjusted in height for different height items, fig. **D**:
 - Lift the glass shelf, align the recess over the support and replace the shelf in a higher or lower position, fig. **D1**.
 - Lift the grid shelf, pull towards you and replace in a higher or lower position, fig. **D2**.
 - The glass shelves* are fitted with stops to prevent them being pulled out accidentally.
- For large appliance, at least 1216 mm high: You can use the front area of the shelf above the fruit and vegetable bins as a convenient area for putting things down on **temporarily**, e.g. if you are rearranging or sorting out the contents of the refrigerator. However, **do not** leave anything there as the items can be pushed backwards or tipped over when you close the door, fig. **D3**.
- The **sectioned glass shelves** can be moved to make space for tall containers: Place the shelf rails provided, fig. **E1**, on the supports on the left and right at the desired height, making sure you use the right-hand rail (R) on the right and the left-hand rail (L) on the left. Insert the glass shelves ① and ② as shown in fig. **E2**. The glass shelf ② with the raised edge must go at the back.
 - If you need to make space for tall containers, simply slide the *front half* of the sectioned glass shelf* carefully underneath the back half, fig. **E2**.

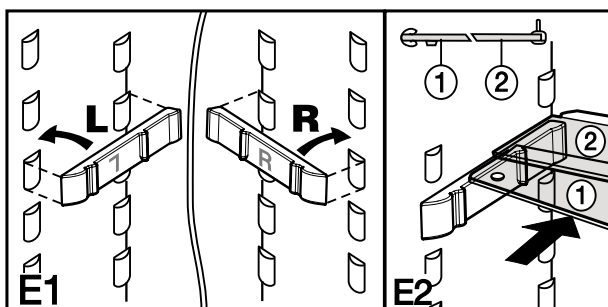
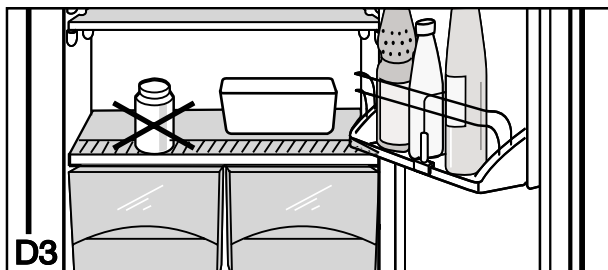
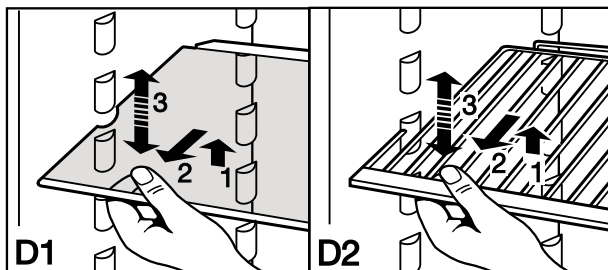
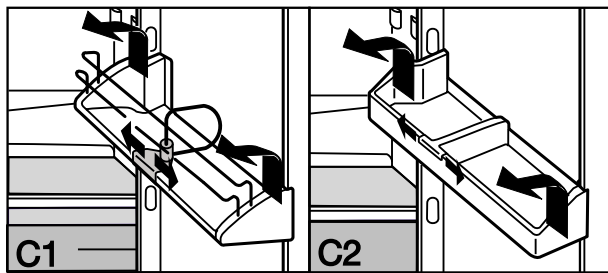

Freezer compartment*

(4-star, if present, depending on model)

You can store frozen food for several months, prepare ice cubes and freeze fresh food in the freezer compartment at temperatures of -18°C and lower (the refrigerator temperature must be set to 5°C).

Freezing fresh food

Fresh food should be frozen to core as quickly as possible. This ensures that the nutritional value, vitamins, appearance and flavour of the food remain intact. To freeze large quantities of fresh food, proceed as follows:

- Approximately 4 hours before placing food in the freezer, set the temperature to 5°C or lower (e.g. 3 °C). Frozen food already stored will then receive an additional cold boost.
- Place the fresh food in the freezer compartment. You can freeze up to **2 kg/24 hours**. Spread out the fresh food on the bottom of the freezer compartment as much as possible and do not allow it to come into contact with frozen food already stored, in order to avoid already frozen food defrosting.
- The fresh food will be frozen through after 24 hours. Set the temperature to the normal setting (e.g. 5°C). The refrigerator will switch back to its normal operation and the freezing procedure is finished.

Note:

The air temperature in the compartment, measured with a thermometer or other measuring equipment, may fluctuate. However this will have little effect on the frozen food when the compartment is full. The core temperature of the frozen food will always be an average of these fluctuations.

Notes on storage

- Deep frozen food can be placed into the cold freezer compartment straight away.
- Avoid putting bottles into the freezer compartment for fast chilling. If you do, do not leave in for longer than one hour as they can burst.
- Do not re-freeze defrosted food; use immediately. This ensures that the nutritional value and flavour will be retained.
- The table below gives guidelines for storage times of various foods in the freezer compartment:

Poultry, beef, lamb	6 to 12 months
Fish, pork	2 to 6 months
Game, rabbit, veal	4 to 8 months
Cold meats, ham	2 to 4 months
Ready meals	2 to 4 months
Fruit and vegetables	6 to 12 months
Cheese, bread, baked goods	2 to 6 months
Yeast pastries	1 to 5 months
Ice cream	2 to 3 months

Whether or not the lower or upper value is applicable depends on the food quality, its processing prior to freezing and the individual household's quality requirements. The lower values always apply to food with a high fat content; fats tend to become rancid.

Making ice cubes

- Fill the ice-cube tray three-quarters full with water.
- Place the ice-cube tray in the appliance and leave it to freeze.
- The ice cubes can be removed from the tray by twisting or by holding upside down for a short time under running water.

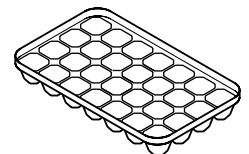

Defrosting, cleaning

Defrosting

The refrigerator compartment

defrosts automatically. The defrost water is evaporated by the heat from the compressor; drops of water on the rear wall are perfectly normal.

- Ensure that the defrost water can flow freely through the drain hole in the rear wall.

The freezer compartment*

After a long period of operation, a thick layer of frost or ice can build up inside the freezer compartment. This increases energy consumption. You should therefore defrost the freezer compartment regularly:

- To defrost, switch off the appliance: Disconnect the appliance from the mains or press the on/off button so that the temperature display goes out. If the display does not go out, the child-proof lock is activated.
- Wrap the frozen goods in newspaper or a blanket and store in a cool place.
- To speed up the defrosting process place a saucepan of hot but not boiling water in the compartment.
Do not use electric heaters or steam cleaners, defrosting sprays or naked flames for defrosting nor any sharp objects for removing the ice. Risk of injury and damage!
- Leave the freezer compartment door and the appliance door open when defrosting. Mop up the defrost water with a sponge or cloth. Clean the appliance afterwards.

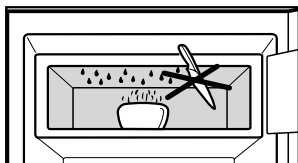

Cleaning

- **Before cleaning, always switch off the appliance. Disconnect from the mains or unscrew or switch off the fuse.**
- Clean the inside and equipment by hand with lukewarm water and a little detergent. Because of the risk of injury and damage to the appliance, steam cleaning equipment should not be used.
- We recommend using a soft cloth and an all-purpose cleaner with a neutral pH value.
- Do not use abrasive sponges or scourers, do not use concentrated cleaning agents and never use cleaning agents containing sand, chloride or acid or chemical solvents.



- Do not allow cleaning water to run down the drain gully or to penetrate the ventilation grilles or electrical components. Wipe the appliance dry.
- Do not damage or remove the type plate on the inside of the appliance. It is very important for servicing purposes.
- The butter dish* and roller plates* can be washed in a dishwasher. The racks, shelves and other components should be cleaned by hand.
- Remove the shelves as shown in the illustration:
 - Lift the glass shelf*, align the recess over the support, tilt to the side and remove towards you at an angle.
 - Lift the grid shelf*, pull towards you and tilt out.
 - Always insert shelves with the raised edge or guard bar at the back pointing upwards, otherwise food may freeze onto the rear wall.
- Always remove the *top* door rack (butter and cheese compartment) together with the flap*. Then press one of the side walls carefully to the outside to release the flap pin. The flap can then be lifted out.
- The shelves and door racks can be dismantled for cleaning. Remove the trims and sides from the glass shelves.
- Remove the protective film from the decorative trims.
- Clean the **drain hole** on the rear wall above the vegetable bins frequently, **arrow in illustration. If necessary, clean with a thin object, e.g. a cotton swab or similar.**

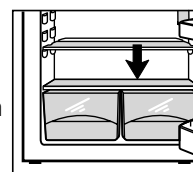
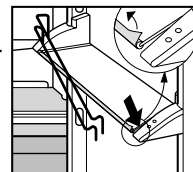
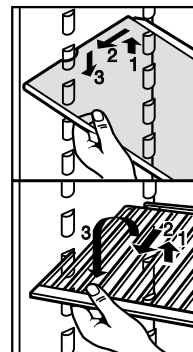

If the appliance is to be **left switched off for any length of time** empty the appliance, disconnect from the mains, clean as described above and leave the door open so as to avoid odours.

Troubleshooting

Your appliance is designed and manufactured for a long life span and reliable operation.

If a malfunction nonetheless occurs during operation, check whether it is due to an operating error. Please note that even during the warranty period the resultant servicing costs in this case will have to be borne by the owner. You may be able to rectify the following faults by checking the possible causes yourself:

Malfunction - Possible cause and remedy

Appliance does not work, display is off

- Is the appliance switched on properly?
- Is the mains plug properly inserted in the socket?
- Is the socket fuse intact?

The interior light does not come on

- Is the appliance switched on?
- Has the door been open for more than 15 minutes? The interior light switches off automatically after the door has been opened for approx. 15 minutes.
- If it does not switch on when the door is opened briefly, but the temperature display is working, it may be defective.

Important! To prevent injury or damage, always ask our customer service department to carry out any repairs and replace the LED interior light.

Caution - class 1M laser radiation. When cover is removed, do not look directly at light through optical instruments.



Loud running noise

- Is the appliance standing firmly on the floor, or does the compressor cause nearby items of furniture or objects to vibrate?
If necessary, move bottles and containers apart.
- *Bubbling noises* are normal. These are caused by the refrigerant flowing round the refrigerant circuit.
A short *clicking sound*: This will be heard whenever the refrigeration unit (the motor) switches on or off automatically.
Motor noise: This will be slightly louder for a brief period when the refrigeration unit switches on.

The temperature is not cold enough

- Is the temperature setting correct? If necessary, set a lower temperature and check the display after 24 hours.
- Does the door close properly?
- Is the appliance built in properly?
- Is the appliance sufficiently well ventilated?
Clear ventilation grilles if necessary.
- Is the ambient temperature too hot? (See "Safety regulations")
- Has the appliance been opened too often or left open too long?
- If applicable, wait until the appliance reaches the required temperature itself.

Customer service and type plate

If none of the above causes apply and you cannot rectify the fault yourself, or if the temperature display reads "F0" to "F5", this means that there is a fault. Please contact your nearest customer service department (see enclosed list for addresses), indicating the **fault number displayed**, together with the **type designation** ①, **service number** ② and **appliance number** ③

as given on the type plate. This will help us to provide you with a faster and more accurate service. The type plate is located inside the appliance on the left-hand side.

Leave the appliance shut until the customer service engineer arrives so as to prevent any further cold loss.

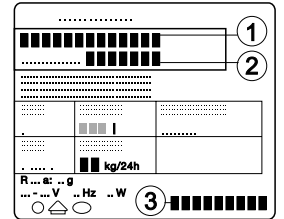

GB

All types and models are subject to continuous improvement and the manufacturer therefore reserves the right to make modifications in the shape, equipment and technology.